

LED间隔柱 LED SPACER SUPPORT



MATERIAL : NYLON 66(UL)

FLAME CLASS : 94V-0,94V-2

COLOR : BLACK,NATURAL

UNIT : mm

用途 : 使LED固定于PC板上, 高度一致, 不断脚。

1

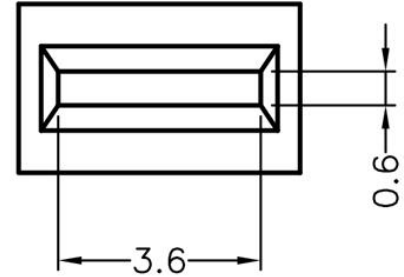
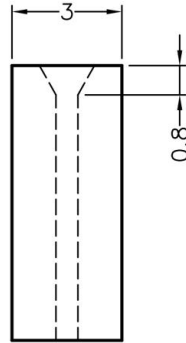
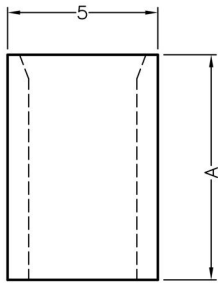

PART NO	A	P	PACKAGE
LEDSS-161	7.5	1	2000
LEDSS-162	8.0	1	2000
LEDSS-163	8.5	1	2000

(规格 / 尺寸) 代码说明 :

P : 装配灯数

LED间隔柱 LED SPACER SUPPORT

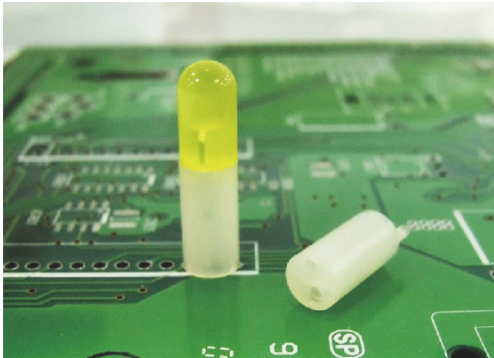

MATERIAL : NYLON 66(UL)

FLAME CLASS : 94V-0,94V-2

COLOR : BLACK,NATURAL

UNIT : mm

用途 : 用于保护 $\varnothing 5$ mm LED立于PC板上, 使高度一致, 中间隔板设计, 接脚不会弯曲、折断、短路, 有定位脚, 不歪斜

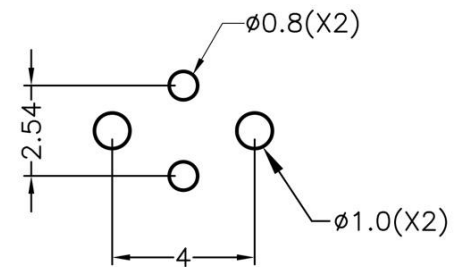
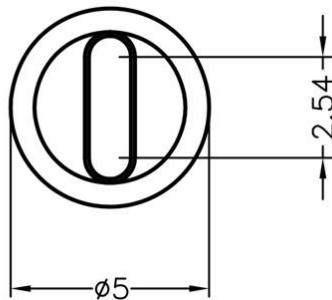
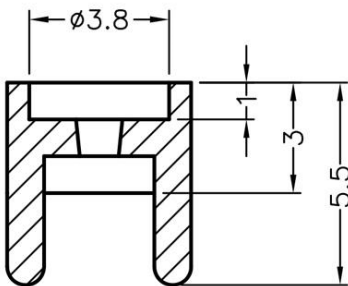

MOUNTING HOLES

PART NO	L	P	PACKAGE
LEDSS-164	5.0	1	1000

(规格 / 尺寸) 代码说明 :

L : LED建议装配规格 P : 装配灯数