

PC板间隔柱 SPACER SUPPORT

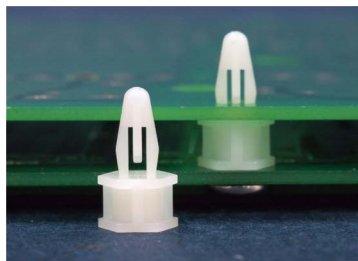

MATERIAL : NYLON 66(UL)
 FLAME CLASS : 94V-0,94V-2
 COLOR : BLACK,NATURAL
 UNIT: mm

用途 : 机板部份用M3铁板自攻螺丝固定, 另一头直接压入PC板。

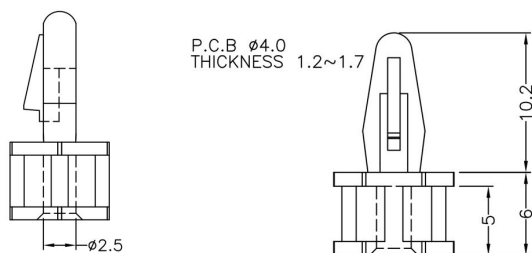
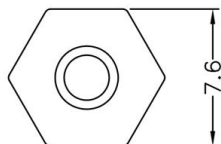

PART NO	PACKAGE
PCSS-037	1000

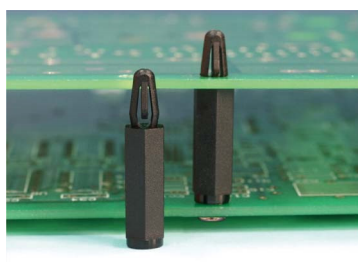

MATERIAL : NYLON 66(UL)
 FLAME CLASS : 94V-0,94V-2
 COLOR : BLACK,NATURAL
 UNIT: mm

用途 : PC板与PC板间之固定, 不占空间

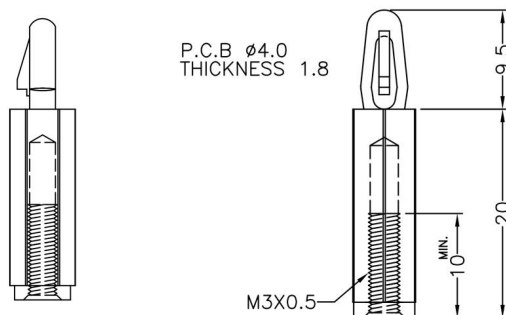
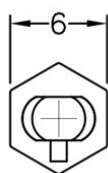

PART NO	PACKAGE
PCSS-038	1000

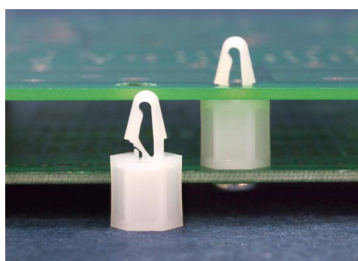

MATERIAL : NYLON 66(UL)
 FLAME CLASS : 94V-0,94V-2
 COLOR : BLACK,NATURAL
 UNIT: mm

用途 : 机板部份用M3.5铁板自攻螺丝固定, 另一头直接压入PC板。

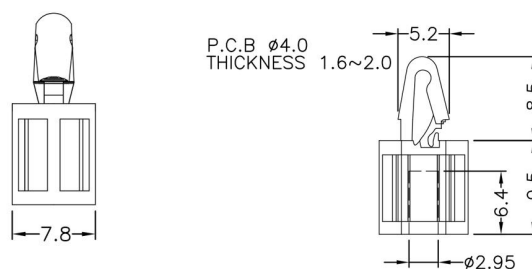

PART NO	PACKAGE
PCSS-039	1000

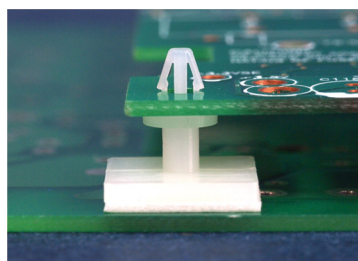

MATERIAL : NYLON 66(UL)
 FLAME CLASS : 94V-0,94V-2
 COLOR : BLACK,NATURAL
 UNIT: mm

用途 : 背胶式, 用于不能钻孔之机板与PC板间之固定

高度不含背胶及离型纸厚度

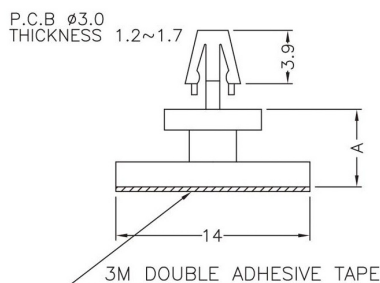
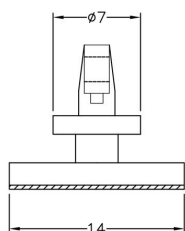

PART NO	A	PACKAGE
PCSS-040	5.6	1000
PCSS-041	8.0	1000
PCSS-042	11.9	1000